

Technical brochure

Safety relief valves

SFV 20-25



SFV 20 - 25 are standard, **back pressure dependent** safety relief valves in angle-way execution, specially designed for protection of vessels and other components against excessive pressure.

The valve is designed to meet the strict quality demands and safety requirements for refrigeration installations, specified by the international classification societies.

The valve is recommended as an external and internal safety relief valve in refrigeration plants. The spring housing is closed tightly to avoid refrigerant leakage.

The inlet flow diameters of the valves are: 18 mm ($\frac{3}{4}$ in.) for SFV 20, and 23 mm (1 in.) for SFV 25.

The valves can be delivered with set pressures between 10 and 25 bar g (145 and 363 psi g).

Standard pressure setting valves having "TÜV Pressure Setting Certificate" with each valve, are also available.

Features

- Applicable for the refrigerants HCFC, HFC, R717 (Ammonia), R744 (CO₂) within a temperature range of -30°C/+100°C (-22°F/+212°F).
- Classification: To get an updated list of certification on the products please contact your local Danfoss Sales Company.

Technical data

- **Refrigerants**
Applicable for the refrigerants HCFC, HFC, R717 (Ammonia), R744 (CO₂) within a temperature range of -30°C/+100°C (-22°F/+212°F).
Flammable hydrocarbons are not recommended.
For further information please contact your local Danfoss Sales Company.
- **Pressure**
Pressure setting range: 10 - 25 bar g (145 - 363 psi g). For further information please contact your local Danfoss Sales Company.

The valves are designed for:
Strength test: 43 bar g (624 psi g)
Leakage safety: Same as set pressure

Important: The SFV safety relief valve is dependent on the back pressure (if the back pressure is higher than the atmospheric pressure, the opening pressure will be higher than stated set pressure).

Special circumstances such as vibrations (which should be avoided) and oscillating pressure may require an increased difference between the operational pressure and the closing pressure.

- **Pressure setting**
The operating pressure of the plant should be at least 15% below the set pressure. This allows a perfect re-seating of the safety relief valve after having been activated.
- **Temperature range**
-30/+100°C (-22/+212°F)



Pressure Equipment Directive (PED)

The SFV-valves are approved in accordance with the European standard specified in the Pressure Equipment Directive and are CE marked. For further details / restrictions - see Installation Instruction

| SFV valves | | |
|----------------|-------------------|-------------------|
| Nominal bore | 18 mm (0.709 in.) | 23 mm (0.906 in.) |
| Classified for | Fluid group I | |
| Category | IV | |

Design

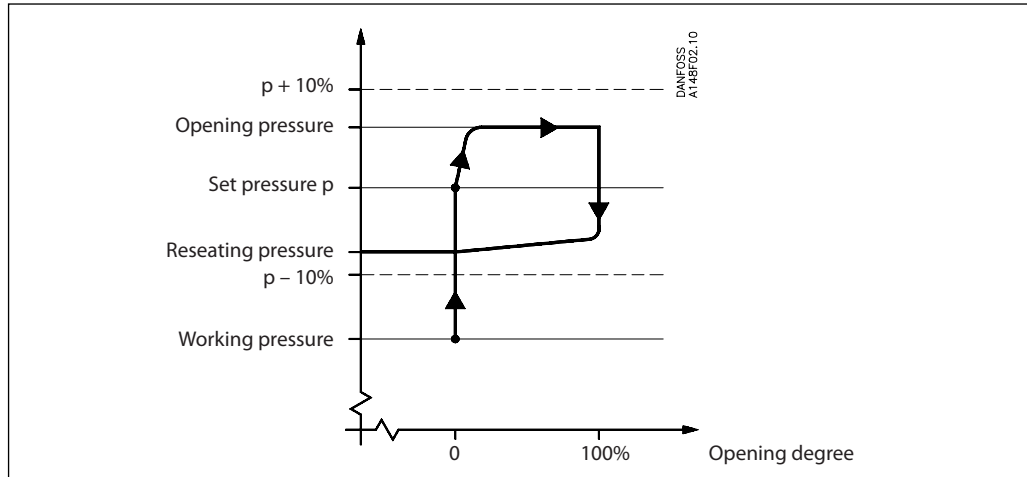

SFV is designed as a **standard safety relief valve** (DIN 3320), which are recommended for refrigeration plants. On a rise in pressure above the set pressure, the safety relief valve will initially start opening slightly, to minimise the outlet of

refrigerant. If the pressure continues to increase, the valve will open fully. The safety relief valve will be fully open before the pressure is 10% higher than set pressure, and fully closed before the pressure is 10% below set pressure.

Connections

Available with the following connections:

- Outside pipe thread T (ISO 228/1)
- Welding fittings (DIN 2448)

Housing

Made of special steel approved for low temperature operation. Spindle and seat are made of stainless steel, to ensure precise operation even during extraordinary conditions. The gasket of the valve cone is made of a special chloroprene (neoprene) compound.

Installation

To ensure exact operation of the safety relief valve it should be installed with the spring housing upwards. If the valve is mounted as an internal safety relief valve without any demand for exact opening pressure, the valve may be fitted with the spring housing in other positions. When the valve is mounted, it is important to avoid the influence of static, dynamic and thermal stress.

A very precise technique has been applied for the production of the seal. However, this seal can still be damaged, if dirt is blown from the pipe system into the valve.

It is recommended that safety relief valves exhaust into the open air with a U-pipe filled with oil on the discharge branch, to prevent dirt from penetrating into the valve. It is also recommended that the valves be installed in pairs in conjunction with the double stop valve type DSV. For further information please see the DSV data sheet.

Re-calibration/servicing

In certain countries the authorities demand that the valves are checked at least once a year (see local rules).

Control/Identification

After adjustment of the set pressure at Danfoss, the valves are sealed. For that reason Danfoss can only guarantee correct operation, as long as the seal remains unbroken.

All valves are provided with a metal plate with the following information:

- Flow diameter
- Set pressure
- Date of production
- Production number
- Type approved code.

Transport/Handling

The valves are fitted with special protection covers and packed into purpose made transportation cartons.

It is important the cover remains fitted around the valve until it is installed.

To ensure the exact and precise operation of the valve it must be handled with care.

Capacity

The design and construction of the safety relief valve has been tested and approved by TÜV. This test comprises control of the function of the valve as well as measuring of the capacity, which is the basis of the curves and tables on the following pages. The values in the table are based on saturated gas.

If e.g. back pressure or superheated gas have to be taken into consideration, the formulas or the Danfoss computation program (DIRcalc™) can be used.

Table 1.

| Valve | Nominal size | | Flow diameter d_o | Flow area A_o | De-rated, certified coefficient of discharge K_{dr} |
|--------|--------------|--------|------------------------|-----------------------|---|
| | Inlet | Outlet | | | |
| SFV 20 | 20 mm | 25 mm | 18 mm | 254 mm ² | 0.54 |
| | ¾ in. | 1 in. | 0.709 in. | 0.394 in ² | |
| SFV 25 | 25 mm | 32 mm | 23 mm | 415 mm ² | 0.48 |
| | 1 in. | 1¼ | 0.906 in. | 0.643 in ² | |

The discharge capacity of the safety relief valves are based on (ISO 4126-1 / prEN 1313 6 (1998)).

$$q_m = 0.2883 \times C \times A_o \times K_{dr} \times K_b \sqrt{\frac{p}{v}}$$

q_m Discharge capacity (kg/h)

C Discharge function depending of the actual refrigerant (κ) see table 2 (-)

A_o Flow area of the safety relief valve (mm²).

K_{dr} De-rated coefficient of discharge ($K_{dr} = K_d \times 0.9$), (the K_{dr} is certified by TÜV) see table 1 (-)

K_b Correction factor for sub-critical flow. (-)

$K_b = 1.0$ when the back pressure is lower than approx. $0.5 \times$ relieving pressure ($P_b < 0.5 \times p$)

For all SFV safety valves $K_b = 1.0$

v Specific volume of the vapour at the relieving pressure p . (m³/kg)

p_{set} Set pressure, the predetermined pressure at which a pressure relief valve under operation starts to open (p_{set} is indicated on the metal plate on the safety relief valve).
(bar gauge)

p_{atm} Atmospheric pressure. (1 bar)

p Relieving pressure, $p = p_{set} \times 1.1 + P_{atm}$ (bar absolute)

For further details see the above-mentioned ISO or EN standards.

Table 2. Properties of Refrigerants

| Refrigerant | Isentropic exponent κ | Discharge function C |
|-------------------------|------------------------------------|------------------------------|
| R22 | 1.17 | 2.54 |
| R134a | 1.12 | 2.50 |
| R404A | 1.12 | 2.49 |
| R410A | 1.17 | 2.54 |
| R717 (Ammonia) | 1.31 | 2.64 |
| R744 (CO ₂) | 1.30 | 2.63 |
| Air | 1.40 | 2.70 |

Safety relief valves, SFV 20-25

Capacity
(cont.)

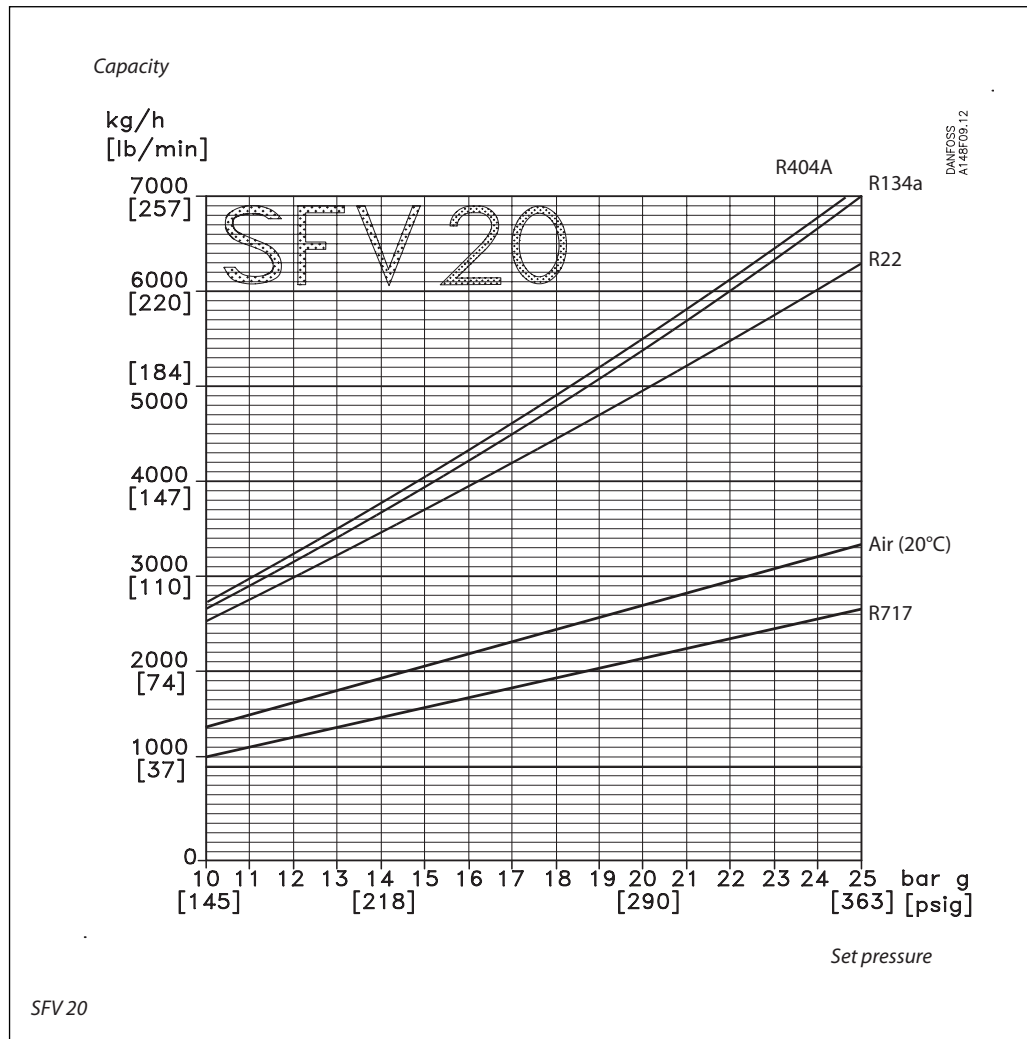

Capacity

| Set pressure | | R22 | R134a | R404A | R717 | Air (20°C) |
|--------------|--------|------|-------|-------|------|------------|
| SFV 20 | | | | | | |
| 13 bar g | kg/h | 3220 | 3430 | 3500 | 1415 | 1790 |
| 189 psi g | lb/min | 118 | 126 | 129 | 52 | 66 |
| 18 bar g | kg/h | 4440 | 4800 | 4900 | 1925 | 2435 |
| 261 psi g | lb/min | 163 | 176 | 180 | 71 | 89 |
| 21 bar g | kg/h | 5215 | 5680 | 5770 | 2235 | 2820 |
| 305 psi g | lb/min | 192 | 209 | 212 | 82 | 104 |
| 25 bar g | kg/h | 6285 | 6980 | 7125 | 2660 | 3335 |
| 363 psi g | lb/min | 231 | 257 | 262 | 98 | 122 |

Safety relief valves, SFV 20-25

Capacity
(cont.)

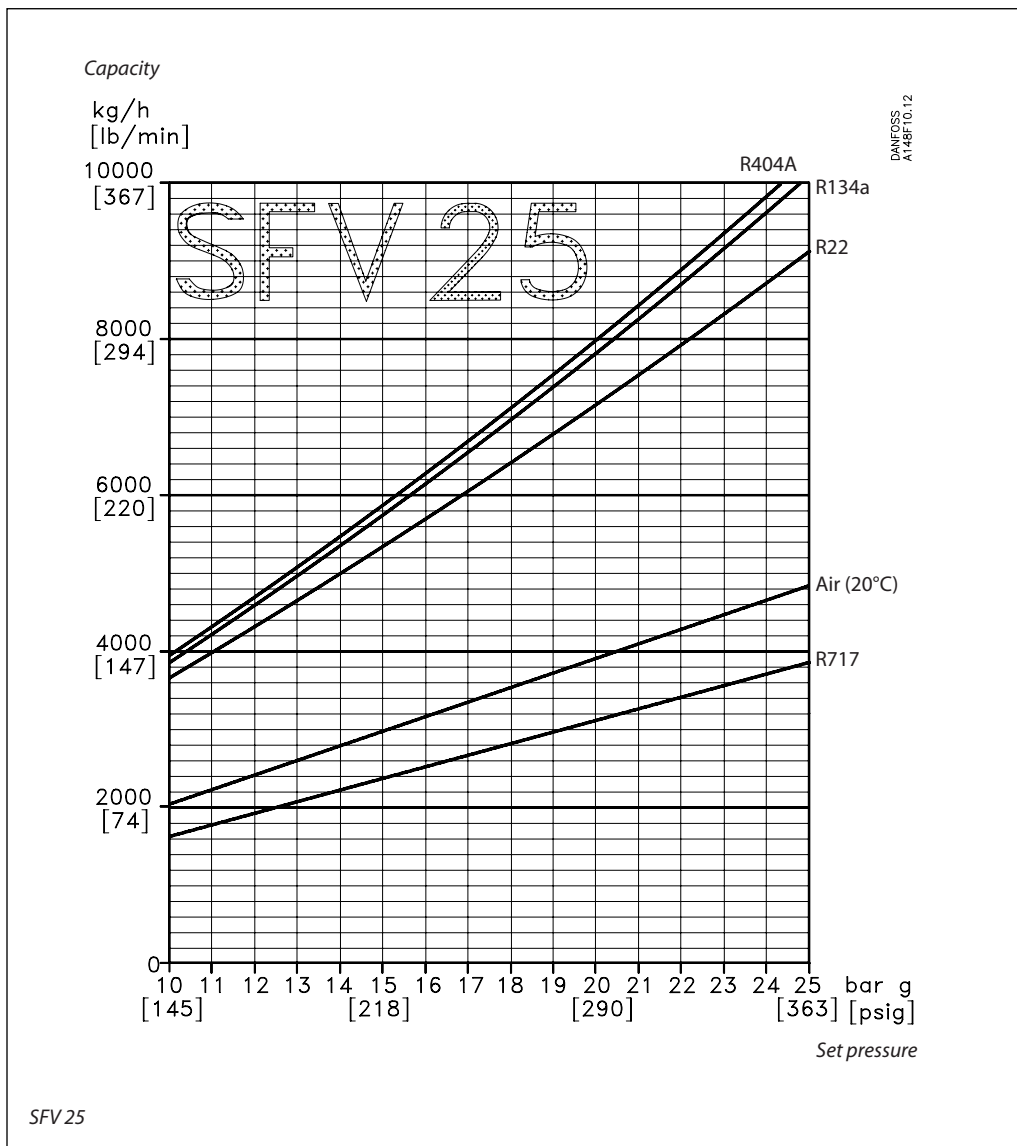

Capacity

| Set pressure | | R22 | R134a | R404A | R717 | Air (20°C) |
|---------------|--------|------|-------|-------|------|------------|
| <i>SFV 25</i> | | | | | | |
| 13 bar g | kg/h | 4670 | 4980 | 5075 | 2050 | 2600 |
| 189 psi g | lb/min | 172 | 183 | 186 | 75 | 96 |
| 18 bar g | kg/h | 6445 | 6965 | 7115 | 2790 | 3530 |
| 261 psi g | lb/min | 237 | 256 | 261 | 103 | 130 |
| 21 bar g | kg/h | 7565 | 8240 | 8370 | 3240 | 4090 |
| 305 psi g | lb/min | 278 | 303 | 308 | 119 | 150 |
| 25 bar g | kg/h | 9120 | 10135 | 10340 | 3860 | 4835 |
| 363 psi g | lb/min | 335 | 372 | 380 | 142 | 178 |

Material specification

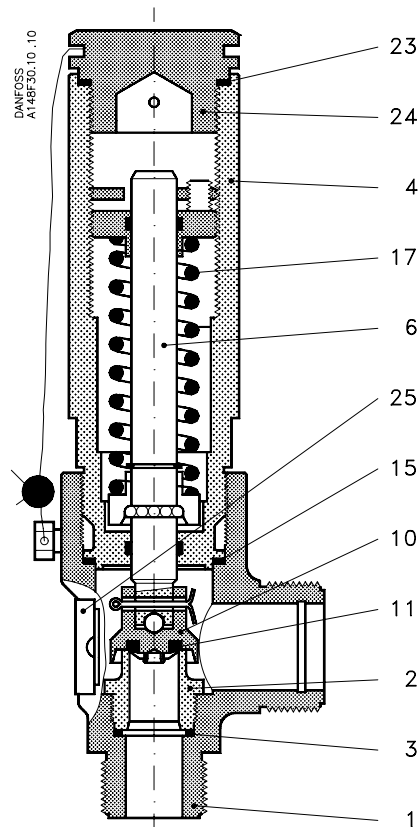

| No. | Part | Material | DIN | ISO | ASTM |
|-----|-----------------|-----------------------------------|------------------------------------|--------------------------------|-----------------------------------|
| 1 | Housing | Steel | G20Mn5 QT *P285QH *TTSt35N | TW 6, 2604/3-75 | Grade 1, A333, A334 * A350 LF2 |
| 2 | Valve seat | Stainless steel | X10CrNiS189, 17440 | Type 17, 683/13 | AISI 303 |
| 3 | Packing washer | Aluminium *Non-asbestos gasket | | | |
| 4 | Valve top | Steel | St. 37.2, 1652 | Fe 360 B, 660 | Grade C, A 283 |
| 6 | Valve spindle | Stainless steel | X10CrNiS189, 17440 | Type 17, 683/13 | AISI 303 |
| 10 | Valve cone | Steel | | | |
| 11 | Valve cone seal | Cloroprene (Neoprene) | | | |
| 15 | Packing washer | Aluminium *Non-asbestos gasket | | | |
| 17 | Spring | Steel | Class C | A 679, 17223 | |
| 23 | Packing washer | Aluminium *Non-asbestos gasket | | | |
| 24 | Plug | Steel | 9S Mn28, 1651 *R St 37.2, 17100 | Type 2, R 683 Fe 360 B, 630 | Grade C, A 283 |
| 25 | Marking label | Aluminium | | | |

* Alternative material

Safety relief valves, SFV 20-25

Connections

T

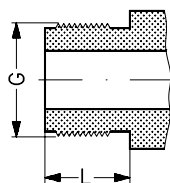

Danfoss
A148B21.11

DIN

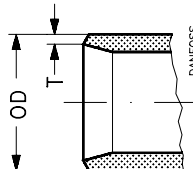

Danfoss
A148B15.10

| Size mm | Size in. | Inlet | Outlet | | L mm | L in. | | |
|---------|----------|-------|--------|--|------|-------|--|--|
|---------|----------|-------|--------|--|------|-------|--|--|

T outside pipe thread, (ISO 228/1)

| | | | | | | | | |
|----|-----|---------|---------|--|----|------|--|--|
| 20 | 3/4 | G 1 1/4 | G 1 1/2 | | 20 | 0.79 | | |
| 25 | 1 | G 1 1/4 | G 1 1/2 | | 20 | 0.79 | | |

| Size mm | Size in. | Inlet (mm) | | Inlet (in.) | | Outlet (mm) | | Outlet (in.) | | | |
|---------|----------|------------|---|-------------|---|-------------|---|--------------|---|--|--|
| | | OD | T | OD | T | OD | T | OD | T | | |

Welding fittings DIN (2448)

| | | | | | | | | | | | |
|----|-----|------|-----|-------|-------|------|-----|-------|-------|--|--|
| 20 | 3/4 | 26.9 | 2.3 | 1.059 | 0.091 | 33.7 | 2.6 | 1.337 | 0.102 | | |
| 25 | 1 | 33.7 | 2.6 | 1.327 | 0.102 | 42.4 | 2.6 | 1.669 | 0.102 | | |

Dimensions and weights

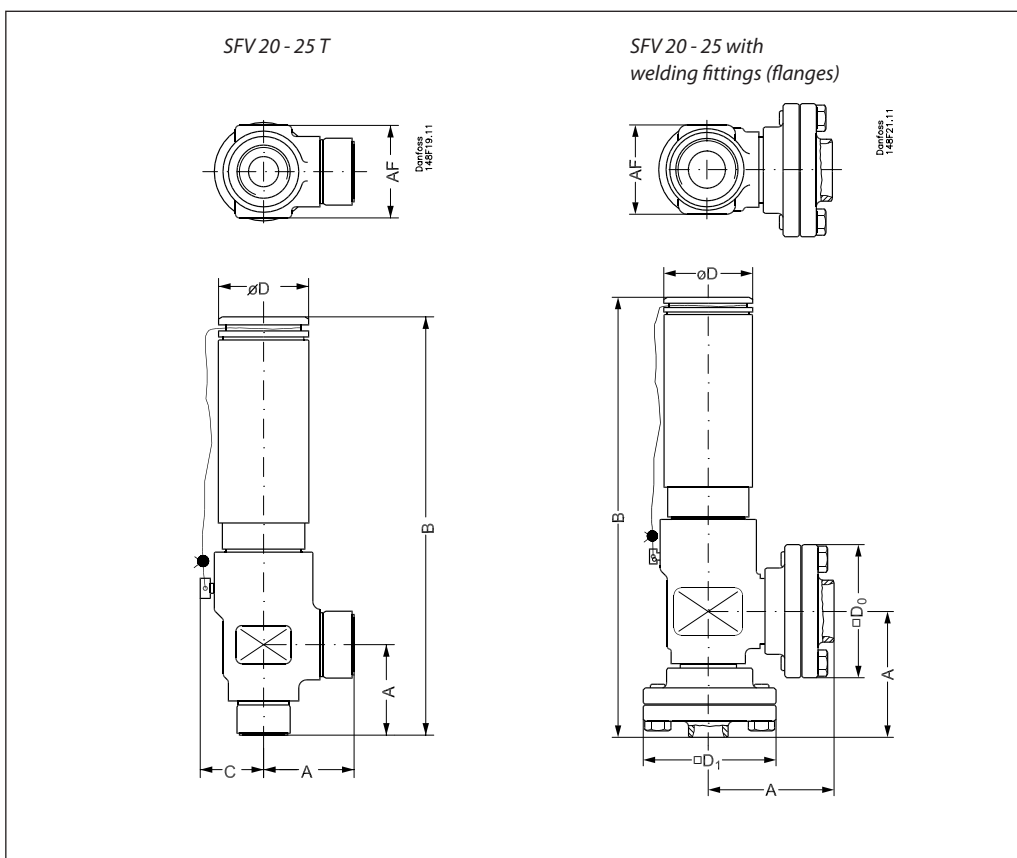

| Valve size | | | A | B | C | □ D ₀ | øD | □ D ₁ | AF | | Weight |
|------------|--|--|---|---|---|------------------|----|------------------|----|--|--------|
|------------|--|--|---|---|---|------------------|----|------------------|----|--|--------|

SFV 20 - 25 T, with threaded connections ISO 228/1 pipe threads

| | | | | | | | | | | | |
|------------------|--------|--|------------|--------------|------------|--|------------|--|------------|--|--------|
| SFV 20 (3/4 in.) | mm in. | | 55 2.17 | 270 10.63 | 40 1.57 | | 60 2.36 | | 60 2.36 | | 4.2 kg |
| SFV 25 (1 in.) | mm in. | | 55 2.17 | 270 10.63 | 40 1.57 | | 60 2.36 | | 60 2.36 | | 4.2 kg |

SFV with welding fittings, DIN 2448

| | | | | | | | | | | | |
|------------------|--------|--|------------|--------------|--|------------|------------|------------|------------|--|--------|
| SFV 20 (3/4 in.) | mm in. | | 85 3.35 | 300 11.81 | | 90 3.54 | 60 2.36 | 90 3.54 | 60 2.36 | | 6.0 kg |
| SFV 25 (1 in.) | mm in. | | 85 3.35 | 300 11.81 | | 90 3.54 | 60 2.36 | 90 3.54 | 60 2.36 | | 6.0 kg |

Specified weights are approximate values only.

Safety relief valves, SFV 20-25

Ordering

How to order

The table below is used to identify the valve required.

Please note that the type codes only serve to identify the valves, some of which may not form part of the standard product range. For further information please contact your local Danfoss Sales Company.

Example for type codes

SFV 20 T 210

Type codes

| Valve type | SFV | Safety relief valve | | | | | | | | | | | | | | | | | | | | | | | | | | | | | | | | | | | | | | | | | | | | | | | | | | | | | | | | | | | | | | | | | | | | | | | | | | | | | | | | | | | | | | | | | | | | | | | | | | | | | | | |
|--|------------------------|---|--|-----------------------|--------|--------|---------------------|-------|---|------------|---|---|------------|---|---|------------|---|---|------------|---|---|------------|---|---|------------|---|---|------------|---|---|------------|---|---|------------|---|---|------------|---|---|------------|---|---|------------|---|---|------------|---|---|------------|---|---|------------|---|---|--|--------|--------|------------|---|---|------------|---|---|------------|---|---|------------|---|---|------------|---|---|------------|---|---|------------|---|---|------------|---|---|------------|---|---|------------|---|---|------------|---|---|------------|---|---|------------|---|---|------------|---|---|------------|---|---|------------|---|---|
| Nominal size in mm (valve size measured on the connection diameter) | 20 25 | <table border="1"> <thead> <tr> <th colspan="2">Available connections</th> </tr> <tr> <th>T</th> <th>DIN welding fitting</th> </tr> </thead> <tbody> <tr> <td>DN 20</td> <td>x</td> </tr> <tr> <td>DN 25</td> <td>x</td> </tr> </tbody> </table> | | Available connections | | T | DIN welding fitting | DN 20 | x | DN 25 | x | | | | | | | | | | | | | | | | | | | | | | | | | | | | | | | | | | | | | | | | | | | | | | | | | | | | | | | | | | | | | | | | | | | | | | | | | | | | | | | | | | | | | | | | | | | | | | |
| Available connections | | | | | | | | | | | | | | | | | | | | | | | | | | | | | | | | | | | | | | | | | | | | | | | | | | | | | | | | | | | | | | | | | | | | | | | | | | | | | | | | | | | | | | | | | | | | | | | | | | | | | | | | | |
| T | DIN welding fitting | | | | | | | | | | | | | | | | | | | | | | | | | | | | | | | | | | | | | | | | | | | | | | | | | | | | | | | | | | | | | | | | | | | | | | | | | | | | | | | | | | | | | | | | | | | | | | | | | | | | | | | | |
| DN 20 | x | | | | | | | | | | | | | | | | | | | | | | | | | | | | | | | | | | | | | | | | | | | | | | | | | | | | | | | | | | | | | | | | | | | | | | | | | | | | | | | | | | | | | | | | | | | | | | | | | | | | | | | | |
| DN 25 | x | | | | | | | | | | | | | | | | | | | | | | | | | | | | | | | | | | | | | | | | | | | | | | | | | | | | | | | | | | | | | | | | | | | | | | | | | | | | | | | | | | | | | | | | | | | | | | | | | | | | | | | | |
| Connections | T | Outside threaded connections: ISO 228/1 Pipe thread - The welding fittings for single mounted safety relief valve must be ordered separately | | | | | | | | | | | | | | | | | | | | | | | | | | | | | | | | | | | | | | | | | | | | | | | | | | | | | | | | | | | | | | | | | | | | | | | | | | | | | | | | | | | | | | | | | | | | | | | | | | | | | | | |
| Pressure setting | | <i>Standard pressure setting: 2××</i> <table border="1"> <thead> <tr> <th></th> <th>SFV 20</th> <th>SFV 25</th> </tr> </thead> <tbody> <tr><td>210</td><td>x</td><td>x</td></tr> <tr><td>211</td><td>x</td><td>x</td></tr> <tr><td>212</td><td>x</td><td>x</td></tr> <tr><td>213</td><td>x</td><td>x</td></tr> <tr><td>214</td><td>x</td><td>x</td></tr> <tr><td>215</td><td>x</td><td>x</td></tr> <tr><td>216</td><td>x</td><td>x</td></tr> <tr><td>217</td><td>x</td><td>x</td></tr> <tr><td>218</td><td>x</td><td>x</td></tr> <tr><td>219</td><td>x</td><td>x</td></tr> <tr><td>220</td><td>x</td><td>x</td></tr> <tr><td>221</td><td>x</td><td>x</td></tr> <tr><td>222</td><td>x</td><td>x</td></tr> <tr><td>223</td><td>x</td><td>x</td></tr> <tr><td>224</td><td>x</td><td>x</td></tr> <tr><td>225</td><td>x</td><td>x</td></tr> </tbody> </table> <i>Standard pressure setting with TÜV certificate: 3××</i> <table border="1"> <thead> <tr> <th></th> <th>SFV 20</th> <th>SFV 25</th> </tr> </thead> <tbody> <tr><td>310</td><td>x</td><td>x</td></tr> <tr><td>311</td><td>x</td><td>x</td></tr> <tr><td>312</td><td>x</td><td>x</td></tr> <tr><td>313</td><td>x</td><td>x</td></tr> <tr><td>314</td><td>x</td><td>x</td></tr> <tr><td>315</td><td>x</td><td>x</td></tr> <tr><td>316</td><td>x</td><td>x</td></tr> <tr><td>317</td><td>x</td><td>x</td></tr> <tr><td>318</td><td>x</td><td>x</td></tr> <tr><td>319</td><td>x</td><td>x</td></tr> <tr><td>320</td><td>x</td><td>x</td></tr> <tr><td>321</td><td>x</td><td>x</td></tr> <tr><td>322</td><td>x</td><td>x</td></tr> <tr><td>323</td><td>x</td><td>x</td></tr> <tr><td>324</td><td>x</td><td>x</td></tr> <tr><td>325</td><td>x</td><td>x</td></tr> </tbody> </table> | | | SFV 20 | SFV 25 | 210 | x | x | 211 | x | x | 212 | x | x | 213 | x | x | 214 | x | x | 215 | x | x | 216 | x | x | 217 | x | x | 218 | x | x | 219 | x | x | 220 | x | x | 221 | x | x | 222 | x | x | 223 | x | x | 224 | x | x | 225 | x | x | | SFV 20 | SFV 25 | 310 | x | x | 311 | x | x | 312 | x | x | 313 | x | x | 314 | x | x | 315 | x | x | 316 | x | x | 317 | x | x | 318 | x | x | 319 | x | x | 320 | x | x | 321 | x | x | 322 | x | x | 323 | x | x | 324 | x | x | 325 | x | x |
| | SFV 20 | SFV 25 | | | | | | | | | | | | | | | | | | | | | | | | | | | | | | | | | | | | | | | | | | | | | | | | | | | | | | | | | | | | | | | | | | | | | | | | | | | | | | | | | | | | | | | | | | | | | | | | | | | | | | | |
| 210 | x | x | | | | | | | | | | | | | | | | | | | | | | | | | | | | | | | | | | | | | | | | | | | | | | | | | | | | | | | | | | | | | | | | | | | | | | | | | | | | | | | | | | | | | | | | | | | | | | | | | | | | | | | |
| 211 | x | x | | | | | | | | | | | | | | | | | | | | | | | | | | | | | | | | | | | | | | | | | | | | | | | | | | | | | | | | | | | | | | | | | | | | | | | | | | | | | | | | | | | | | | | | | | | | | | | | | | | | | | | |
| 212 | x | x | | | | | | | | | | | | | | | | | | | | | | | | | | | | | | | | | | | | | | | | | | | | | | | | | | | | | | | | | | | | | | | | | | | | | | | | | | | | | | | | | | | | | | | | | | | | | | | | | | | | | | | |
| 213 | x | x | | | | | | | | | | | | | | | | | | | | | | | | | | | | | | | | | | | | | | | | | | | | | | | | | | | | | | | | | | | | | | | | | | | | | | | | | | | | | | | | | | | | | | | | | | | | | | | | | | | | | | | |
| 214 | x | x | | | | | | | | | | | | | | | | | | | | | | | | | | | | | | | | | | | | | | | | | | | | | | | | | | | | | | | | | | | | | | | | | | | | | | | | | | | | | | | | | | | | | | | | | | | | | | | | | | | | | | | |
| 215 | x | x | | | | | | | | | | | | | | | | | | | | | | | | | | | | | | | | | | | | | | | | | | | | | | | | | | | | | | | | | | | | | | | | | | | | | | | | | | | | | | | | | | | | | | | | | | | | | | | | | | | | | | | |
| 216 | x | x | | | | | | | | | | | | | | | | | | | | | | | | | | | | | | | | | | | | | | | | | | | | | | | | | | | | | | | | | | | | | | | | | | | | | | | | | | | | | | | | | | | | | | | | | | | | | | | | | | | | | | | |
| 217 | x | x | | | | | | | | | | | | | | | | | | | | | | | | | | | | | | | | | | | | | | | | | | | | | | | | | | | | | | | | | | | | | | | | | | | | | | | | | | | | | | | | | | | | | | | | | | | | | | | | | | | | | | | |
| 218 | x | x | | | | | | | | | | | | | | | | | | | | | | | | | | | | | | | | | | | | | | | | | | | | | | | | | | | | | | | | | | | | | | | | | | | | | | | | | | | | | | | | | | | | | | | | | | | | | | | | | | | | | | | |
| 219 | x | x | | | | | | | | | | | | | | | | | | | | | | | | | | | | | | | | | | | | | | | | | | | | | | | | | | | | | | | | | | | | | | | | | | | | | | | | | | | | | | | | | | | | | | | | | | | | | | | | | | | | | | | |
| 220 | x | x | | | | | | | | | | | | | | | | | | | | | | | | | | | | | | | | | | | | | | | | | | | | | | | | | | | | | | | | | | | | | | | | | | | | | | | | | | | | | | | | | | | | | | | | | | | | | | | | | | | | | | | |
| 221 | x | x | | | | | | | | | | | | | | | | | | | | | | | | | | | | | | | | | | | | | | | | | | | | | | | | | | | | | | | | | | | | | | | | | | | | | | | | | | | | | | | | | | | | | | | | | | | | | | | | | | | | | | | |
| 222 | x | x | | | | | | | | | | | | | | | | | | | | | | | | | | | | | | | | | | | | | | | | | | | | | | | | | | | | | | | | | | | | | | | | | | | | | | | | | | | | | | | | | | | | | | | | | | | | | | | | | | | | | | | |
| 223 | x | x | | | | | | | | | | | | | | | | | | | | | | | | | | | | | | | | | | | | | | | | | | | | | | | | | | | | | | | | | | | | | | | | | | | | | | | | | | | | | | | | | | | | | | | | | | | | | | | | | | | | | | | |
| 224 | x | x | | | | | | | | | | | | | | | | | | | | | | | | | | | | | | | | | | | | | | | | | | | | | | | | | | | | | | | | | | | | | | | | | | | | | | | | | | | | | | | | | | | | | | | | | | | | | | | | | | | | | | | |
| 225 | x | x | | | | | | | | | | | | | | | | | | | | | | | | | | | | | | | | | | | | | | | | | | | | | | | | | | | | | | | | | | | | | | | | | | | | | | | | | | | | | | | | | | | | | | | | | | | | | | | | | | | | | | | |
| | SFV 20 | SFV 25 | | | | | | | | | | | | | | | | | | | | | | | | | | | | | | | | | | | | | | | | | | | | | | | | | | | | | | | | | | | | | | | | | | | | | | | | | | | | | | | | | | | | | | | | | | | | | | | | | | | | | | | |
| 310 | x | x | | | | | | | | | | | | | | | | | | | | | | | | | | | | | | | | | | | | | | | | | | | | | | | | | | | | | | | | | | | | | | | | | | | | | | | | | | | | | | | | | | | | | | | | | | | | | | | | | | | | | | | |
| 311 | x | x | | | | | | | | | | | | | | | | | | | | | | | | | | | | | | | | | | | | | | | | | | | | | | | | | | | | | | | | | | | | | | | | | | | | | | | | | | | | | | | | | | | | | | | | | | | | | | | | | | | | | | | |
| 312 | x | x | | | | | | | | | | | | | | | | | | | | | | | | | | | | | | | | | | | | | | | | | | | | | | | | | | | | | | | | | | | | | | | | | | | | | | | | | | | | | | | | | | | | | | | | | | | | | | | | | | | | | | | |
| 313 | x | x | | | | | | | | | | | | | | | | | | | | | | | | | | | | | | | | | | | | | | | | | | | | | | | | | | | | | | | | | | | | | | | | | | | | | | | | | | | | | | | | | | | | | | | | | | | | | | | | | | | | | | | |
| 314 | x | x | | | | | | | | | | | | | | | | | | | | | | | | | | | | | | | | | | | | | | | | | | | | | | | | | | | | | | | | | | | | | | | | | | | | | | | | | | | | | | | | | | | | | | | | | | | | | | | | | | | | | | | |
| 315 | x | x | | | | | | | | | | | | | | | | | | | | | | | | | | | | | | | | | | | | | | | | | | | | | | | | | | | | | | | | | | | | | | | | | | | | | | | | | | | | | | | | | | | | | | | | | | | | | | | | | | | | | | | |
| 316 | x | x | | | | | | | | | | | | | | | | | | | | | | | | | | | | | | | | | | | | | | | | | | | | | | | | | | | | | | | | | | | | | | | | | | | | | | | | | | | | | | | | | | | | | | | | | | | | | | | | | | | | | | | |
| 317 | x | x | | | | | | | | | | | | | | | | | | | | | | | | | | | | | | | | | | | | | | | | | | | | | | | | | | | | | | | | | | | | | | | | | | | | | | | | | | | | | | | | | | | | | | | | | | | | | | | | | | | | | | | |
| 318 | x | x | | | | | | | | | | | | | | | | | | | | | | | | | | | | | | | | | | | | | | | | | | | | | | | | | | | | | | | | | | | | | | | | | | | | | | | | | | | | | | | | | | | | | | | | | | | | | | | | | | | | | | | |
| 319 | x | x | | | | | | | | | | | | | | | | | | | | | | | | | | | | | | | | | | | | | | | | | | | | | | | | | | | | | | | | | | | | | | | | | | | | | | | | | | | | | | | | | | | | | | | | | | | | | | | | | | | | | | | |
| 320 | x | x | | | | | | | | | | | | | | | | | | | | | | | | | | | | | | | | | | | | | | | | | | | | | | | | | | | | | | | | | | | | | | | | | | | | | | | | | | | | | | | | | | | | | | | | | | | | | | | | | | | | | | | |
| 321 | x | x | | | | | | | | | | | | | | | | | | | | | | | | | | | | | | | | | | | | | | | | | | | | | | | | | | | | | | | | | | | | | | | | | | | | | | | | | | | | | | | | | | | | | | | | | | | | | | | | | | | | | | | |
| 322 | x | x | | | | | | | | | | | | | | | | | | | | | | | | | | | | | | | | | | | | | | | | | | | | | | | | | | | | | | | | | | | | | | | | | | | | | | | | | | | | | | | | | | | | | | | | | | | | | | | | | | | | | | | |
| 323 | x | x | | | | | | | | | | | | | | | | | | | | | | | | | | | | | | | | | | | | | | | | | | | | | | | | | | | | | | | | | | | | | | | | | | | | | | | | | | | | | | | | | | | | | | | | | | | | | | | | | | | | | | | |
| 324 | x | x | | | | | | | | | | | | | | | | | | | | | | | | | | | | | | | | | | | | | | | | | | | | | | | | | | | | | | | | | | | | | | | | | | | | | | | | | | | | | | | | | | | | | | | | | | | | | | | | | | | | | | | |
| 325 | x | x | | | | | | | | | | | | | | | | | | | | | | | | | | | | | | | | | | | | | | | | | | | | | | | | | | | | | | | | | | | | | | | | | | | | | | | | | | | | | | | | | | | | | | | | | | | | | | | | | | | | | | | |

Important!

Where products need to be certified according to specific certification societies, the relevant information should be included at the time of order.

Safety relief valves, SFV 20-25

Ordering (cont.)

Certified SFV valves with standard set pressure

| Size | | Construction and test facilities are approved by TÜV | | |
|------|-----|--|---------------|-----------------|
| mm | in. | Type | Bar g (psi g) | Part no. |
| 20 | 3/4 | SFV20 T 210 | 10 (145) | 2416+254 |
| 20 | 3/4 | SFV20 T 211 | 11 (160) | 2416+255 |
| 20 | 3/4 | SFV20 T 212 | 12 (174) | 2416+256 |
| 20 | 3/4 | SFV20 T 213 | 13 (189) | 2416+150 |
| 20 | 3/4 | SFV20 T 214 | 14 (203) | 2416+257 |
| 20 | 3/4 | SFV20 T 215 | 15 (218) | 2416+258 |
| 20 | 3/4 | SFV20 T 216 | 16 (232) | 2416+259 |
| 20 | 3/4 | SFV20 T 217 | 17 (247) | 2416+260 |
| 20 | 3/4 | SFV20 T 218 | 18 (261) | 2416+151 |
| 20 | 3/4 | SFV20 T 219 | 19 (276) | 2416+261 |
| 20 | 3/4 | SFV20 T 220 | 20 (290) | 2416+262 |
| 20 | 3/4 | SFV20 T 221 | 21 (305) | 2416+152 |
| 20 | 3/4 | SFV20 T 222 | 22 (319) | 2416+241 |
| 20 | 3/4 | SFV20 T 223 | 23 (334) | 2416+263 |
| 20 | 3/4 | SFV20 T 224 | 24 (348) | 2416+264 |
| 20 | 3/4 | SFV20 T 225 | 25 (363) | 2416+183 |

Certified SFV valves with standard set pressure and TÜV pressure setting certificate with each valve

| Size | | Each valve is certified by a representative from TÜV | | |
|------|-----|--|---------------|-----------------|
| mm | in. | Type | Bar g (psi g) | Part no. |
| 20 | 3/4 | SFV20 T 310 | 10 (145) | 2416+285 |
| 20 | 3/4 | SFV20 T 311 | 11 (160) | 2416+286 |
| 20 | 3/4 | SFV20 T 312 | 12 (174) | 2416+287 |
| 20 | 3/4 | SFV20 T 313 | 13 (189) | 2416+160 |
| 20 | 3/4 | SFV20 T 314 | 14 (203) | 2416+288 |
| 20 | 3/4 | SFV20 T 315 | 15 (218) | 2416+289 |
| 20 | 3/4 | SFV20 T 316 | 16 (232) | 2416+290 |
| 20 | 3/4 | SFV20 T 317 | 17 (247) | 2416+291 |
| 20 | 3/4 | SFV20 T 318 | 18 (261) | 2416+161 |
| 20 | 3/4 | SFV20 T 319 | 19 (276) | 2416+292 |
| 20 | 3/4 | SFV20 T 320 | 20 (290) | 2416+293 |
| 20 | 3/4 | SFV20 T 321 | 21 (305) | 2416+162 |
| 20 | 3/4 | SFV20 T 322 | 22 (319) | 2416+294 |
| 20 | 3/4 | SFV20 T 323 | 23 (334) | 2416+295 |
| 20 | 3/4 | SFV20 T 324 | 24 (348) | 2416+296 |
| 20 | 3/4 | SFV20 T 325 | 25 (363) | 2416+186 |

Certified SFV valves with standard set pressure

| Size | | Construction and test facilities are approved by TÜV | | |
|------|-----|--|---------------|-----------------|
| mm | in. | Type | Bar g (psi g) | Part no. |
| 25 | 1 | SFV25 T 210 | 10 (145) | 2416+265 |
| 25 | 1 | SFV25 T 211 | 11 (160) | 2416+266 |
| 25 | 1 | SFV25 T 212 | 12 (174) | 2416+267 |
| 25 | 1 | SFV25 T 213 | 13 (189) | 2416+153 |
| 25 | 1 | SFV25 T 214 | 14 (203) | 2416+268 |
| 25 | 1 | SFV25 T 215 | 15 (218) | 2416+269 |
| 25 | 1 | SFV25 T 216 | 16 (232) | 2416+270 |
| 25 | 1 | SFV25 T 217 | 17 (247) | 2416+271 |
| 25 | 1 | SFV25 T 218 | 18 (261) | 2416+154 |
| 25 | 1 | SFV25 T 219 | 19 (276) | 2416+272 |
| 25 | 1 | SFV25 T 220 | 20 (290) | 2416+273 |
| 25 | 1 | SFV25 T 221 | 21 (305) | 2416+155 |
| 25 | 1 | SFV25 T 222 | 22 (319) | 2416+242 |
| 25 | 1 | SFV25 T 223 | 23 (334) | 2416+274 |
| 25 | 1 | SFV25 T 224 | 24 (348) | 2416+275 |
| 25 | 1 | SFV25 T 225 | 25 (363) | 2416+184 |

Certified SFV valves with standard set pressure and TÜV pressure setting certificate with each valve

| Size | | Each valve is certified by a representative from TÜV | | |
|------|-----|--|---------------|-----------------|
| mm | in. | Type | Bar g (psi g) | Part no. |
| 25 | 1 | SFV25 T 310 | 10 (145) | 2416+297 |
| 25 | 1 | SFV25 T 311 | 11 (160) | 2416+298 |
| 25 | 1 | SFV25 T 312 | 12 (174) | 2416+299 |
| 25 | 1 | SFV25 T 313 | 13 (189) | 2416+163 |
| 25 | 1 | SFV25 T 314 | 14 (203) | 2416+300 |
| 25 | 1 | SFV25 T 315 | 15 (218) | 2416+301 |
| 25 | 1 | SFV25 T 316 | 16 (232) | 2416+302 |
| 25 | 1 | SFV25 T 317 | 17 (247) | 2416+303 |
| 25 | 1 | SFV25 T 318 | 18 (261) | 2416+164 |
| 25 | 1 | SFV25 T 319 | 19 (276) | 2416+304 |
| 25 | 1 | SFV25 T 320 | 20 (290) | 2416+305 |
| 25 | 1 | SFV25 T 321 | 21 (305) | 2416+165 |
| 25 | 1 | SFV25 T 322 | 22 (319) | 2416+306 |
| 25 | 1 | SFV25 T 323 | 23 (334) | 2416+307 |
| 25 | 1 | SFV25 T 324 | 24 (348) | 2416+308 |
| 25 | 1 | SFV25 T 325 | 25 (363) | 2416+187 |

Flanges and gaskets

| Type | Code No. |
|----------------------------------|-----------------|
| Flanges + gaskets set for SFV 20 | 148F3020 |
| Flanges + gaskets set for SFV 25 | 148F3021 |

Repair kit

| Type | Code No. |
|--|-----------------|
| Repair kit for SFV 20 (gaskets and cone) | 2453+082 |
| Repair kit for SFV 25 (gaskets and cone) | 2453+083 |

